

## RS Smart

5

JAAR  
GARANTIE



Ons nieuwste product is het RS Smart. Gekenmerkt door de zijkappen zonder schroeven, de onderlat welke in de kast verdwijnt en tweedelige geleiders en snelle montage en demontage geeft dit product een luxe uitstraling.

De kast blijft perfect recht en het doek hangt strak. Door de speciale constructie met verborgen onderlat neemt de RS Smart veel minder licht weg dan andere producten van dit type. Een doorslaggevend voordeel van dit model is de mogelijkheid van revisie aan de onderkant van de kast.

## RS Smart 85

Max breedte 300 cm • Max hoogte 200 cm

### RS Smart 85 schuin

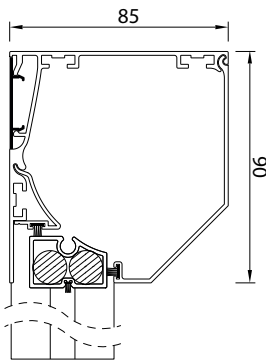

### RS Smart 85 recht

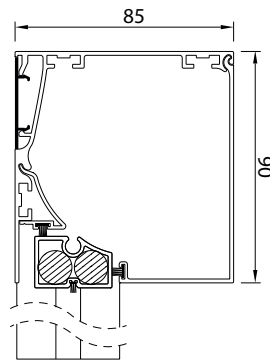

### RS Smart 85 halfrond

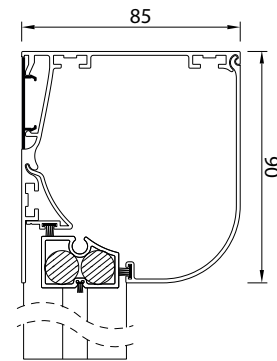

### Onderlat

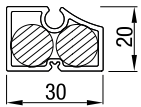

## RS Smart 100

Max breedte 400 cm • Max hoogte 300 cm

### RS Smart 100 schuin

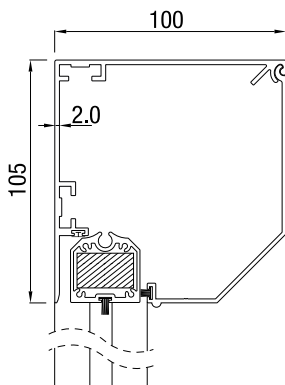

### RS Smart 100 halfrond

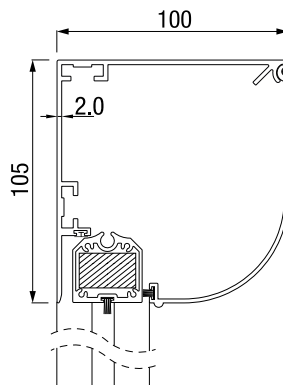

### RS Smart 100 recht

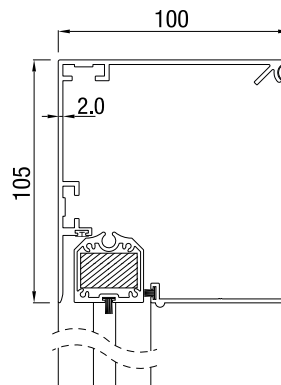

### RS Smart 100 boog

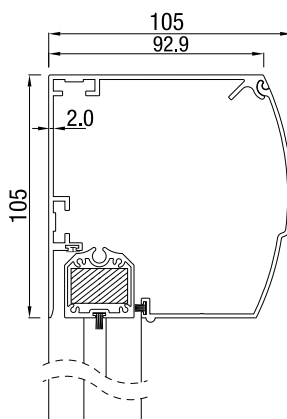

### Onderlat

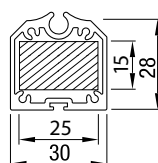

## RS Smart 130

Max breedte 600 cm • Max hoogte 600 cm • Max oppervlak 30 m<sup>2</sup>

### RS Smart 130 schuin

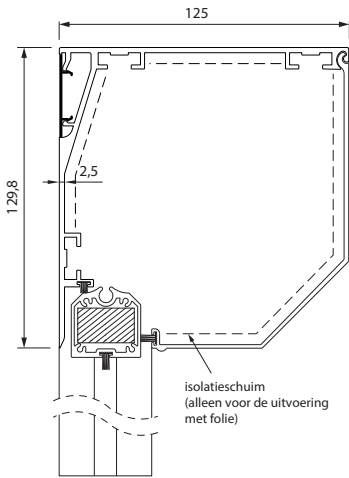

### RS Smart 130 halfrond

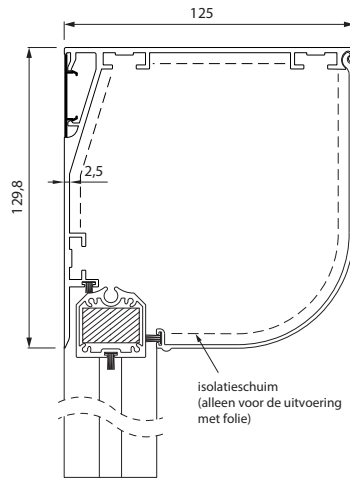

### RS Smart 130 recht

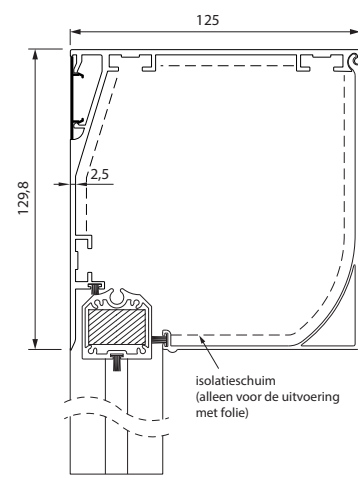

### RS Smart 130 boog

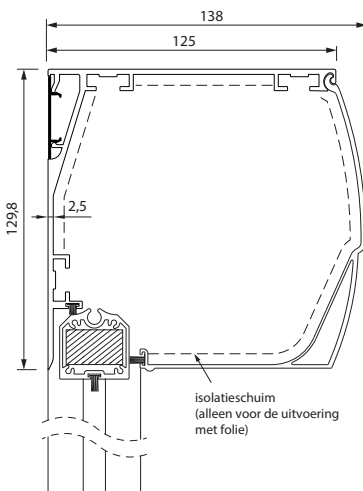

### RS Smart 130 recht

revisie kap openen vanaf de onderkant

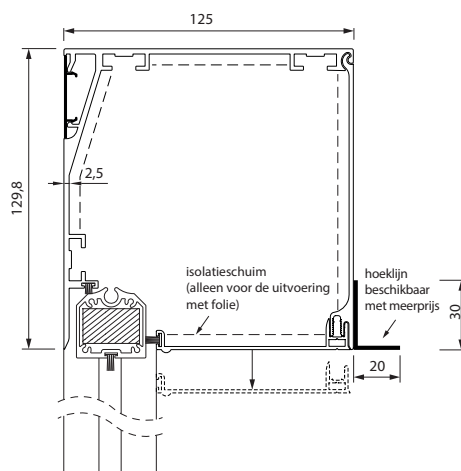

### Onderlat

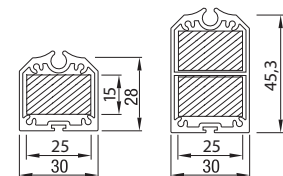

\* voor producten boven 4m breed

### Folie opties

#### Optie 1\*

Folie over de hele breedte, doek onder en boven minimal 11,5 cm

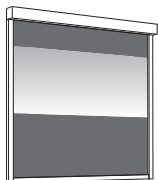

#### Optie 2\*

Folie in het midden. Minimummaat van het doek onder, boven en op de zijken is 11,5 cm

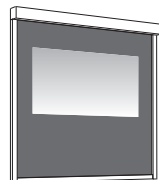

#### Optie 3\*

Folie over de hele oppervlakte

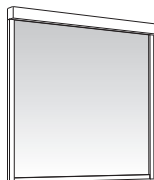

\*Maximale folie afmetingen 4 x 3 m

### Montage steunen

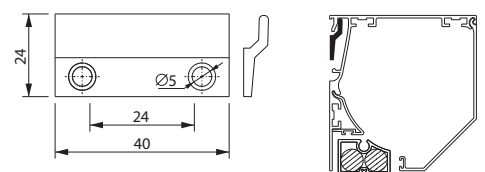

Steunen zijn inclusief.

Als standaard gebruiken wij

2 steunen bij breedte onder 249 cm  
3 steunen bij breedte boven 250 cm  
4 steunen bij breedte boven 350 cm

## Geleiders

### STG-S \*

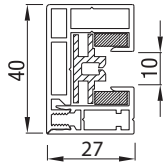

SMART  
TWEEDELIGE  
GELEIDER-SMALL

\* Rs Smart 85

### STG

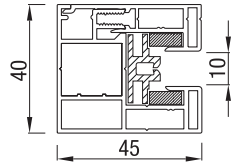

SMART  
TWEEDELIGE  
GELEIDER

### MSTG

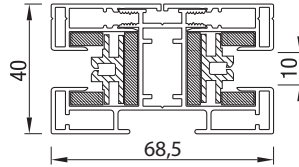

### geleider met klik STG-Click

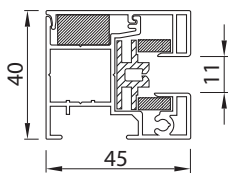

### opvulprofiel

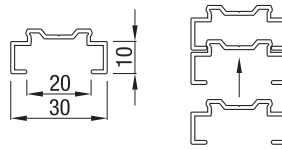

### afstandshouder

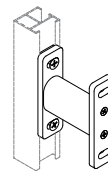

Standaard 7cm, 10 cm  
Andere afmetingen mogelijk,  
prijs op aanvraag

## Standaard omkasting RS Smart

kleur dichtst bij RAL\*

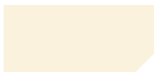

RAL 9001  
Crémewit

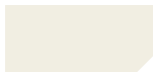

RAL 9010  
Wit



RAL 9016  
Verkeerswit



Technisch Zilver  
(Geanodiseerd)



RAL 7016  
Antracietgrijs



RAL 7039  
Kwartsgrijs



RAL 8019  
Bruin

structuurlak\*



STR 9506  
Blank aluminium



STR 9507  
Grijs aluminium



STR 7539  
Kwartsgrijs



STR 7516  
Antracietgrijs



tiger 29/80081  
Iron Glimmer (structuurlak)

Meerprijzen bij moffelwerk:

Andere RAL kleuren +15%  
Andere RAL kleuren metallic +20%  
Structuurlak +20%

\* Bij moffelwerk kunnen tintverschillen voorkomen.  
Geringe kleurafwijkingen zijn voorbehouden.